

**TELESTEPS**



**No.1 in telescopic work tools**



# COMBI LINE

Freestanding or leaning, you decide.





# THREE IS BETTER THAN ONE

Freestanding-, leaning- ladder and A-ladder, all in one.

Our Combi Line is exactly what it sounds like, a freestanding ladder fully extended for maximum working height, but at a limited height can be used as an A-frame ladder, easily adjusted and used as a leaning ladder. This makes the ladder optimal for those who need a multifunctional ladder for different types of situations.

## ERGONOMIC AND SAFE

To be and feel safe on a ladder is our highest priority, that's why we have a lot of built-in safety features. The red tabs are a clear indicator when the rungs are locked and safe to climb. Our new 80 mm wide and level rungs with grooved channels give you great grip and is very comfortable to stand on also for longer periods of time.

The patented triangular tubes make the ladder stronger and more flex-resistant thanks to our engineering. The shape also makes a perfect grip for your hand when climbing up and down the ladder. Like all our ladders Combi Line is equipped with both rubber tops and feet all to avoid slipping.

## FLEXIBLE AND EASY TO USE

The very nature of telescoping ladders makes them easy to transport in almost any vehicle but more importantly easy to carry back and forth the working site even when you need to use an elevator or if there is lack of space.

The newly developed Autolift makes it even easier to carry Combi Line, especially when you often move the ladder during your workday.

In just a couple of seconds you can transform Combi Line from a free-standing ladder into a leaning ladder. Just push the buttons on the back side of the ladder and pull the bottom rungs upwards until you can attach our Easy Lock to the above rung. Done.



# IT'S ALL IN THE DETAILS

A ladder is a ladder they say. But we know that it is the small details that makes the big difference.

## SAFE LOCKING

Red indicator tabs to ensure your safety every time.

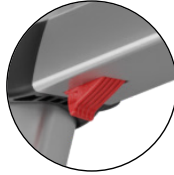

## ERGONOMIC

Wide and level rungs to minimize slipping and reduce fatigue.



## SAFER RUNGS

Rungs with grooved channels to disperse dirt.



## INTEGRATED HANDLE

The Combi Line has an integrated handle making it very easy to carry.

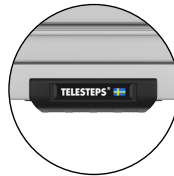

## RUBBER FEET

Maximizing surface contact to avoid slipping.

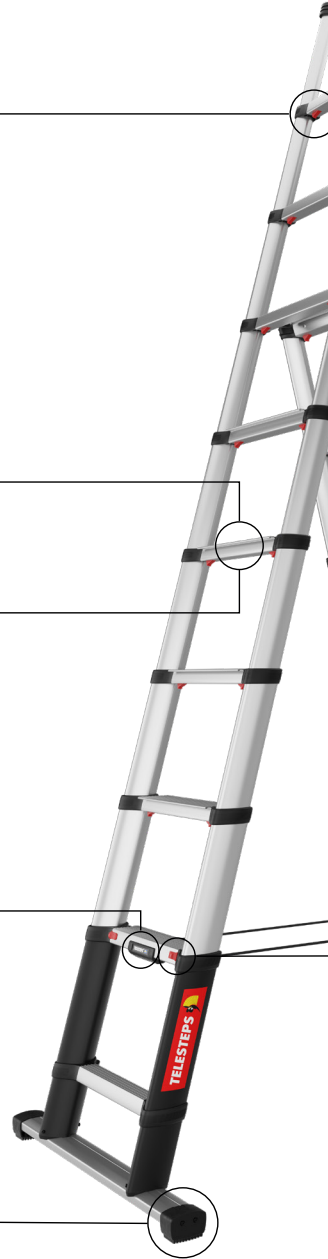
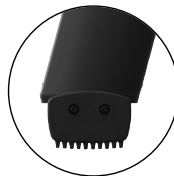

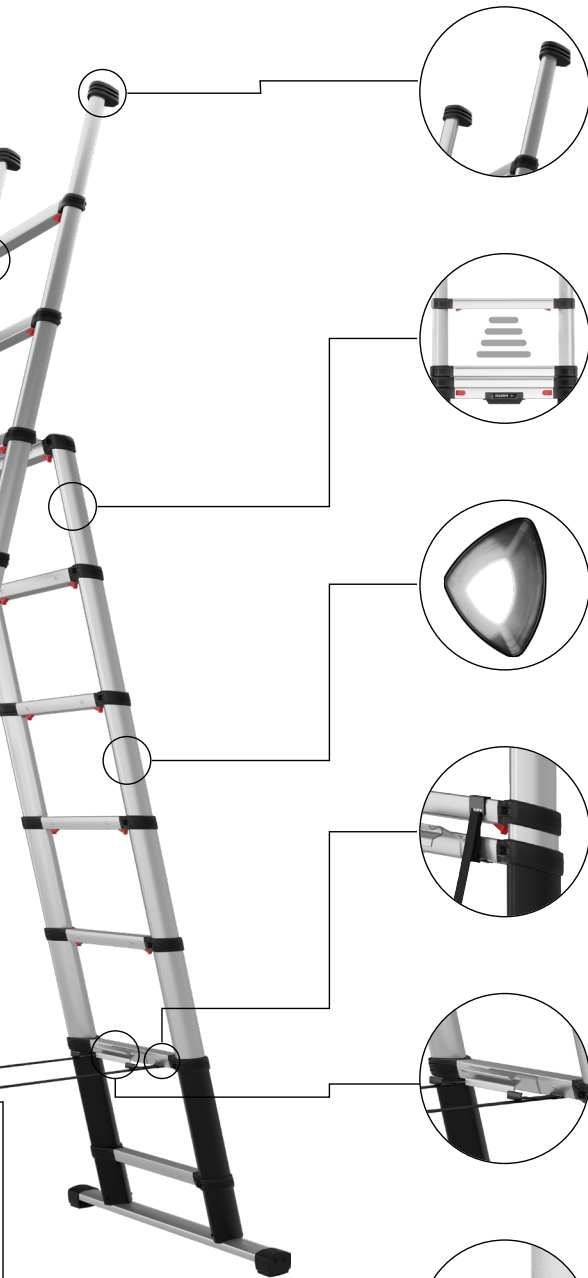

## **RUBBER TOP SECTION**

Works individually on uneven surfaces.  
Avoids sliding and damaging walls.

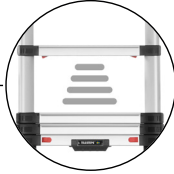

## **SLOW CLOSE SYSTEM**

Controlled closing to avoid pinching fingers.

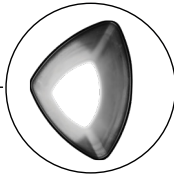

## **TRIANGULAR DESIGN**

Twist and flex resistant by nature.



## **EASY LOCK**

2 ladders in 1 – Easy to transform from standing ladder to a leaning ladder.



## **AUTOLIFT**

Connecting front and back side of the ladder, when lifting.

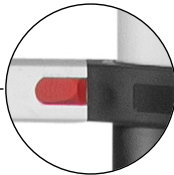

## **SMART & SAFE UNLOCKING**

2 push buttons on each side for closing the ladder.

Autostep® - Automatic unlocking system when closing the ladder.

# TWO SIZES

Our Combi Line is available in two different heights.



## COMBI LINE 2,3

Art. No.	72423-681
Tread width	80 mm
Working height	3,1 m
Length, closed	0,73 m
Width	0,68 m
Weight	14,1 kg
Max load	150 kg
Max users	1

## COMBI LINE 3,0

Art. No.	72430-681
Tread width	80 mm
Working height	3,8 m
Length, closed	0,79 m
Width	0,75 m
Weight	19,5 kg
Max load	150 kg
Max users	1

# ACCESSORIES

Our accessories makes your everyday work a bit easier.

To further improve our products and personalize them to your specific needs we have a number of accessories to choose from.



## TOOL TRAY

This small but handy accessory allows you to place tools, screws, electrical instruments and other equipment's, on a practical tray while you are working.

Art. No. 9202-101



## MAINTENANCE KIT

To even extend the functionality and secure the safety of your ladder we have created a maintenance kit including a cleaning sponge and a microfiber towel.

Art. No. 9205-101



## WALL MOUNT

The perfect wall mount to store and keep your Telesteps ladder safe. With Telesteps stylish wall mount, you can be sure to find your ladder at the same place each time – without taking up space.

Art. No. 9195-601



## SPARE PARTS

Our high quality makes the products last a long time. Very long time. This might causes parts to wear out and sometimes have to be replaced. Read more at our website [telesteps.com](http://telesteps.com).



Many years ago we created an icon in the world of ladders and today we are recognized as the world leader in telescopic work tools. With our R&D and world class production based in Sweden, our brand and products are renowned for its quality and design by our users worldwide, ensuring we always put safety and quality first.



Telesteps AB, Box 362, 573 24 Tranås, Sweden  
info@telesteps.com | www.telesteps.com